



Designed. Engineered. Remarkable Value.

Bale Handling Equipment

The quality choice in hay attachments



www.worksaver.com

Engineered, Designed and Manufactured in the USA



Get more done with a Worksaver hay attachment.



DBH-449



BSF-1523

3-pt. Bale Spears

Worksaver has the attachment that is right for your hay handling needs. Our 3-pt. mounted bale spears are designed, depending on model, to handle up to 3,000 lb. bales (DBH-6000 rated at 6,000 lbs.). The line features forged spring steel spears designed for hard center bales allowing easier spear penetration of and withdrawal from bale(s). All models (except BSF-1523) use a 42mm diameter bolt-in spear with a useable length of 42-inches providing outstanding service life. Most models are designed to mount to Category I/II hitches unless noted.



HS-330



HS-2200

3-pt. Bale Spears

Model	Item No.	Description	Weight
BSF-1523	830235	Rated for round bales up to 1,800 lbs. Tapered main spear has usable length of 44" with welded balance spears. Fits Cat. I/II hitch.	57 lbs.
HS-2200	832310	Rated for round bales up to 2,200 lbs. Bolt-in forged spear with 42" usable length. Two welded balance spears. Cat. I/II Quick Hitch compatible.	72 lbs.
HS-3000	830775	Dual bolt-in forged spears with 42" usable length. Spears are spaced 26" apart allowing bale to be picked up & not lose its orientation. Rated at 3,000 lbs. Fits Cat. I/II Quick Hitches.	78 lbs.
HS-330	832615	Triple bolt-in forged spears with 26" usable length. Spears are spaced 28-1/2" apart, ideal for mid-size square bales. Overall unit width of 57.75". Fits Cat. II/III hitch & Quick Hitches.	163 lbs.
DBH-449	832610	Four bolt-in forged spears with 42" usable length. Designed to handle two round bales at once. Overall unit width of 96". Fits Cat. II/III hitch & Quick Hitches.	250 lbs.
DBH-6000	834100	Four bolt-in spears, square frame design allowing transport of two 5-ft. or 6-ft. dia. round bales at once. Rated at 6,000 lbs. Overall unit width of 76". Fits Cat. II/III hitch & Quick Hitches.	295 lbs.



WARNING: Do not exceed weight lifting capacity of your 3-pt. hitch. Damage to equipment or personal injury could occur.



DBH-6000

Choose the **WORKSAVER** Way to Handle Your Hay



Bale Unroller & Handler

Ideal for unrolling large round bales for feeding. Conserves hay – by unrolling only what cattle will eat in one hour. Easy operation from the tractor seat. Allows easy feeding relocation, which reduces manure buildup and spreads seeds. The HHU-2045 fits Cat. I/II hitches, as well as Cat. I or II Quick Hitch.



HHU-2045

Model	Item No.	Description	Weight
HHU-2045	831340	3-pt. Hay Handler/Unroller rated at 2,200 lbs. Designed for round bales either 4' or 5' in width and up to 6' in diameter (requires a 2-1/2" x 8" cylinder and hoses, which are not included).	310 lbs.



WARNING: Do not exceed weight lifting capacity of your 3-pt. hitch. Damage to equipment or personal injury could occur.



Bucket Bale Spears

Quickly convert your front loader bucket into a tool for handling large round bales. Our CBSF-3028 triple bale spear is designed to handle rectangular bales. Each spear mounts under the bucket cutting edge with heavy angle iron for support and utilizes the bucket underside for leverage. The bolt-on or chain system is used to firmly lock the attachment on the bucket. These units use tapered "forged bolt-in spears with a useable length of 42".

 **WARNING:** Bale spears are to be inserted into bales. DO NOT use spears as forks.



CBSF-3028



CBSF-2000

Model	Item No.	Description	Weight
BBSF-20	830185	Bolt-on Bucket Bale Spear for round bales. Rated at 2,000 lbs. Bolt-in spear has usable length of 42". Requires drilling one 17/32" dia. hole in the bucket. Bolt-together design.	65 lbs.
CBSF-2000	830190	Clamp-on Bucket Bale Spear for round bales. Rated at 2,000 lbs. Uses chain & turnbuckle system. Bolt-in spear has usable length of 42". Bolt-together design.	76 lbs.
CBSF-2028	831920	Clamp-on Bucket Dual Bale Spear for round bales. Rated at 3,000 lbs. Uses chain & turnbuckle system. Bolt-in spears have usable length of 42". NOTE: Spears must be inserted into the bale.	101 lbs.
CBSF-3028	831955	Clamp-on bucket triple bale spear for square bales. Rated at 4,000 lbs. uses dual chain & turnbuckles. Bolt-in spears have usable length of 42". NOTE: Spears must be inserted into the bale.	185 lbs.



CBSF-2028



BBSF-20

Choose the **WORKSAVER** Way to Handle Your Hay



LS-Series Pin-on Type

The LS-Series front loader attachments are designed for pin-on type front loaders only. This economical attachment allows for easy handling of round bales.



WARNING: Do not exceed weight lifting capacity of your loader. Damage to equipment or personal injury could occur.

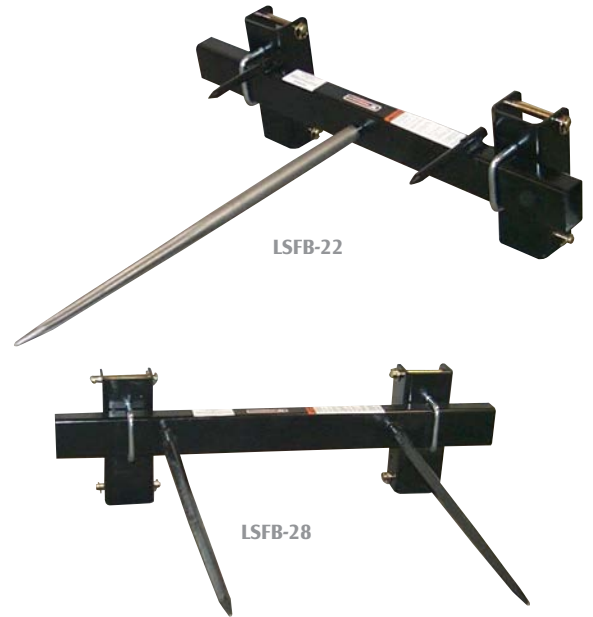

Model	Item No.	Description	Weight
LSFB-22	832015	Designed for pin-type loaders only, and rated at 2,200 lbs. Bolt-in spear has usable length of 42". For use with round bales. Includes pin-on brackets & 1.0" dia. pins.	150 lbs.
LSFB-28	832020	Designed for pin-type loaders only, and rated at 3,000 lbs. Bolt-in spears have usable length of 42". For use with round bales. Includes pin-on brackets & 1.0" dia. pins.	165 lbs.

Spears & Spear Kits

Item No.	Description	Weight
831290	1,800 lb. tapered forged replacement spear with nut. Usable length of 44".	22 lbs.
831273	2,200 lb. tapered forged replacement spear with nut. Usable length of 44".	22 lbs.
830928	2,200 lb. forged bolt-in replacement spear and bolt. Usable length of 42".	19 lbs.
832217	2,200 lb. bolt-in replacement spear kit. Includes forged spear, sleeve, and bolt. Usable length of 42". Requires 2.28" dia. hole in tubing frame.	26 lbs.
832215	2,200 lb. bolt-in replacement spear kit with cast steel socket (patent pending). Includes forged spear, bolt, and casting that welds to your 3" x 3" or larger square/rectangular frame. Usable length of 42".	29 lbs.
831180	1,800 lb. forged replacement spear kit. Includes spear with nut and weld in sleeve (2" O.D.). Spear length 49" overall, 44" usable.	23 lbs.
831190	2,200 lb forged replacement spear kit. Includes spear with nut and weld in sleeve (2" O.D.). Spear length 49" overall, 44" usable.	20 lbs.



Spear kit #832215



Spear kit #831190



RW Spin Off

Designed as an efficient hay management tool for moving and feeding round bales, the RW Spin Off hydraulically rotates the bale, unwinding the hay into a windrow. Rotates in both directions for easy feeding and allows the operator to unroll what the cattle will clean up in one hour, eliminating wasted hay. Also, by changing the feeding location each day, the operator can eliminate manure buildup. Available in three models and designed to fit Category II or Category III 3-pt hitches (FSO-906), front loaders (FLSO-907) and skid steers (SSSO-908). All models are hydraulically driven for better operator control, provide easy operation from the cab of tractors or skid steers and feature a forged tapered spear for easier bale penetration. All have usable spear length of 53".



WARNING: Do not exceed weight lifting capacity of your equipment. Damage to equipment or personal injury could occur.

Model	Item No.	Description	Weight
FSO-906	831000	3-pt. hydraulically driven bale spin off for Cat. II/III size tractors (pin & bushing kit 830295 allows use on Cat. I). Requires 8-10 gpm of hydraulic flow. Tapered forged spear.	250 lbs.
FLSO-907	831020	Front loader mounted hydraulically driven bale spin off. Requires 8-10 gpm of hydraulic flow. Tapered forged spear. Optional pin-on brackets or interfacing brackets for most popular quick-attach front loaders are available with loader arm distance of 54" or less.	288 lbs.
SSSO-908	831030	Skid steer mounted hydraulically driven bale spin off. Requires 8-10 gpm of hydraulic flow. Designed to interface with "Universal" skid steer quick attach system.	325 lbs.



SSSO-908



FLSO-907

Choose the **WORKSAVER** Way to Handle Your Hay



FLBS-Series Loader Attachments

The FLBS-Series is designed for use on pin-on type front loaders, they can be paired with a set of optional pin-on or interfacing quick-attach brackets available for most of today's loaders. The FLBS-2200 and FLBS-3000 deliver outstanding hay-handling performance when used to transport round bales. FLBS-6000 is designed to transport two round bales at once, reducing trips across the field.



FLBS-3000



FLBS-2200

Model	Item No.	Description	Weight
FLBS-2200	832380	Single bolt-in forged spear with usable length of 42". Rated at 2,200 lbs. Single 1-1/4" diameter balance spear usable length 16". Optional interfacing brackets for most loaders are available.	121 lbs.
FLBS-3000	832385	Dual bolt-in forged spears with usable length of 42". Rated at 3,000 lbs. Optional interfacing brackets for most loaders are available.	136 lbs.
FLBS-6000	834160	Front loader dual bale handler. Transport two round bales at once. Unit is 76" x 24". Rated at 6,000 lbs. Requires loader brackets be welded to the unit.	280 lbs.



WARNING: Do not exceed weight lifting capacity of your loader. Damage to equipment or personal injury could occur.

FLBS-Series

Loader Attachments

Handling large or mid-size rectangular bales is easier using one of our 3 or 4 spear models to perform the job. All models feature tapered “forged” spring steel spears. Optional pin-on brackets or interfacing brackets for most popular quick-attach front loaders are available. Select models are convertible for use on a 3-pt. hitch with the addition of the optional bolt-on ear assembly (not Quick Hitch adaptable).



FLBS-330/340 –
Shown as FLBS-330

Model	Item No.	Description	Weight
FLBS-330	832390	Triple bolt-in forged spears with usable length of 26". Spears are spaced 26-1/2" apart. Rated at 3,000 lbs. For handling mid-size square bales. Optional interfacing brackets for most loaders are available. Use of optional uprights 831095 are required to handle two bales.	164 lbs.
FLBS-340	832395	Triple bolt-in forged spears with usable length of 42". Spears are spaced 26-1/2" apart. Rated at 4,000 lbs. For handling larger square bales. Optional interfacing brackets for most loaders are available. Use of optional uprights 831095 are required to handle two bales.	198 lbs.
FLBS-432	832405	Four bolt-in spears with usable length of 26". Spears are spaced 24" apart. Frame is 79-1/2" wide for handling mid-size square bales. Optional interfacing brackets for most loaders are available. Use of optional uprights 831095 are required to handle two bales.	169 lbs.
FLBS-449	832410	Four bolt-in forged spears with usable length of 42". Spears are spaced 24" apart. Frame is 79-1/2" wide for handling large square bales. Optional interfacing brackets for most loaders are available. Use of optional uprights 831095 are required to handle two bales.	212 lbs.
Optional Bolt-in Uprights & Bolt-on Ear Assembly			
	831095	Optional bolt-in uprights for FLBS models 330/340/432/449 to allow handling two bales.	32 lbs.
	831815	Bolt on assembly allows select FLBS models (will not fit FLBS-2200) to be used on a Cat. II 3-pt hitch (requires 830345 standard brackets with 830358 bushing kit makes unit Quick Hitch compatible).	17 lbs.

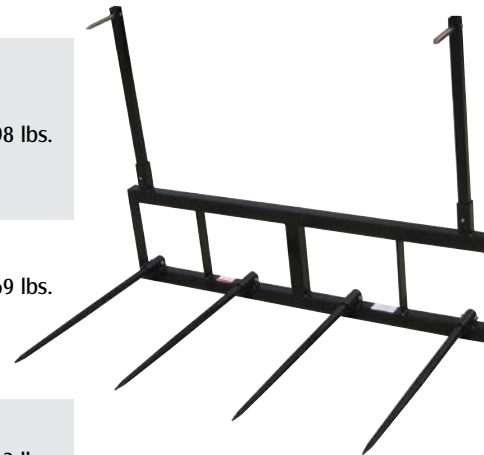

FLBS-449/432 –
Shown as FLBS-449
with optional uprights



WARNING: Do not exceed weight lifting capacity of your loader. Damage to equipment or personal injury could occur.

Choose the **WORKSAVER** Way to Handle Your Hay



Large Bale Squeeze for Wrapped (or Dry) Square/Round Bales

Boost productivity when handling wrapped or un-wrapped large square bales (unit also will handle round bales) with a WorkSaver bale squeeze. Striking the right balance between clamping force and gentleness these models feature arms made with round tubing to secure the bale without damaging the wrap. Large square bales are the preferred choice of dairies and livestock operators and models are offered to suit their needs. Models are available to fit "universal" skid steer mounts, and Global/Euro mounts.



SSLBS-48

Model	Item No.	Description	Weight
SSLBS-48	834170	Large Bale Squeeze for skid steer loaders and tractor front loaders that use the industry standard "universal" skid steer quick-attach system. Handles bales from 48" to 96" in length, up to 2,500 lbs. Hydraulic cylinder included. Shipped with hoses and flat faced couplers.	665 lbs.
GLBS-48	834180	Large Bale Squeeze for tractor front loaders that use the Euro/Global quick-attach system. Handles bales from 48" to 96" in length, up to 2,500 lbs. Hydraulic cylinder included. Shipped less hoses.	680 lbs.



GLBS-48



WARNING: Do not exceed weight lifting capacity of your loader. Damage to equipment or personal injury could occur.

Skid Steer Bale Hand for Wrapped (or Dry) Round Bales

The Skid Steer “Bale Hand” gently handles large round wrapped or unwrapped bales. Features smooth curved arms to prevent wrapped bale puncture when clamping. Fits skid steer and front loaders with the “Universal” quick-attach system.

Model	Item No.	Description	Weight
SSBH-2072	832965	Skid Steer “Bale Hand” designed to handle 4’ to 6’ round bales. Both arms open to clamp bale. Hydraulic cylinder included. Rated at 2,200 lbs.	572 lbs.

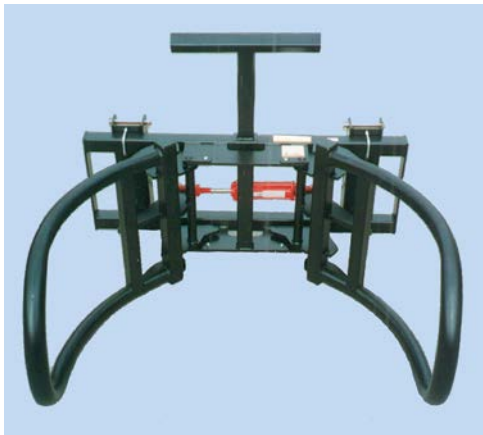

UBH-2072

UBH-2072 & GLBH-2072 for Wrapped (or Dry) Round Bales

The UBH-2072 & GLBH-2072 will gently handle large round wrapped or unwrapped bales with weight up to 2,200 lbs. They feature smooth curved clamping arms to prevent puncturing wrapped bales. UBH-2072 mates with pin-on brackets or interfacing brackets for most popular quick-attach front loaders are available for loaders with arm distance of 54” or less. GLBH-2072 is designed for loaders with the Euro/Global style tool carrier.

Model	Item No.	Description	Weight
UBH-2072	832940	Designed to handle round bales from 4’ to 6’. Both arms open and close to clamp bale. Hydraulic cylinder included. Rated at 2,200 lbs.	529 lbs.
GLBH-2072	832980	Designed for Euro/Global tool carriers to handle round bales from 4’ to 6’. Both arms open and close to clamp bale. Hydraulic cylinder included. Rated at 2,200 lbs.	570 lbs.



WARNING: Do not exceed weight lifting capacity of your loader. Damage to equipment or personal injury could occur.

Choose the **WORKSAVER** Way to Handle Your Hay



Quality attachments, Built for the way you work!

Integrated-Frame Design for John Deere Loaders

Integrated-frame design engineered to fit select John Deere loaders that utilize the John Deere OEM quick-attach systems. Rugged all welded frame design with durable bolt-in forged spear(s) provides years of dependable service.

Integrated-frame design for John Deere loader models that utilize the 300/400 series style carrier & 500 series style carrier.

Model	Item No.	Description	Weight
JDBS-412	832290	Single bolt-in forged spear with usable length of 42". Rated at 2,200 lbs. Two balance spikes.	121 lbs.
JDBS-423	832320	Dual bolt-in forged spears spaced 30" apart, with usable length of 42". Rated at 3,000 lbs.	156 lbs.
JDBS-433	832330	Triple bolt-in forged spears spaced 28" apart, with usable length of 26". Rated at 3,000 lbs.	164 lbs.
JDBS-434	832335	Triple bolt-in forged spears spaced 28" apart, with usable length of 42". Rated at 4,000 lbs.	191 lbs.
Optional Bolt-on Upright Kit			
	831095	Optional bolt-on upright kit for handling two bales. Fits models JDBS-433 & -434.	32 lbs.

Integrated-frame design for John Deere 600/700 series loaders (Non-Global) that utilize the 600/700 series style carrier.

Model	Item No.	Description	Weight
JDBS-612	832340	Single bolt-in forged spear with usable length of 42". Rated at 2,200 lbs. Two balance spikes.	176 lbs.
JDBS-623	832350	Dual bolt-in forged spears spaced 30" apart, with usable length of 42". Rated at 3,000 lbs.	196 lbs.
JDBS-633	832355	Triple bolt-in forged spears spaced 28" apart, with usable length of 26". Rated at 3,000 lbs.	204 lbs.
JDBS-634	832630	Triple bolt-in forged spears spaced 28" apart, with usable length of 42". Rated at 4,000 lbs.	231 lbs.
Optional Bolt-on Upright Kit			
	831095	Optional bolt-on upright kit for handling two bales. Fits models JDBS-633 & -634.	32 lbs.



WARNING: Do not exceed weight lifting capacity of your loader. Damage to equipment or personal injury could occur.



JDBS-412

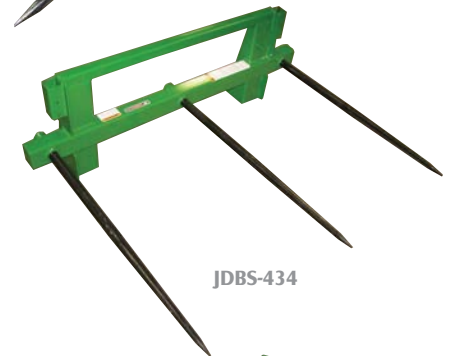

JDBS-434

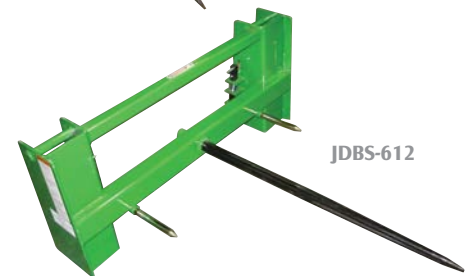

JDBS-612



JDBS-623



JDBS-634
with optional
uprights

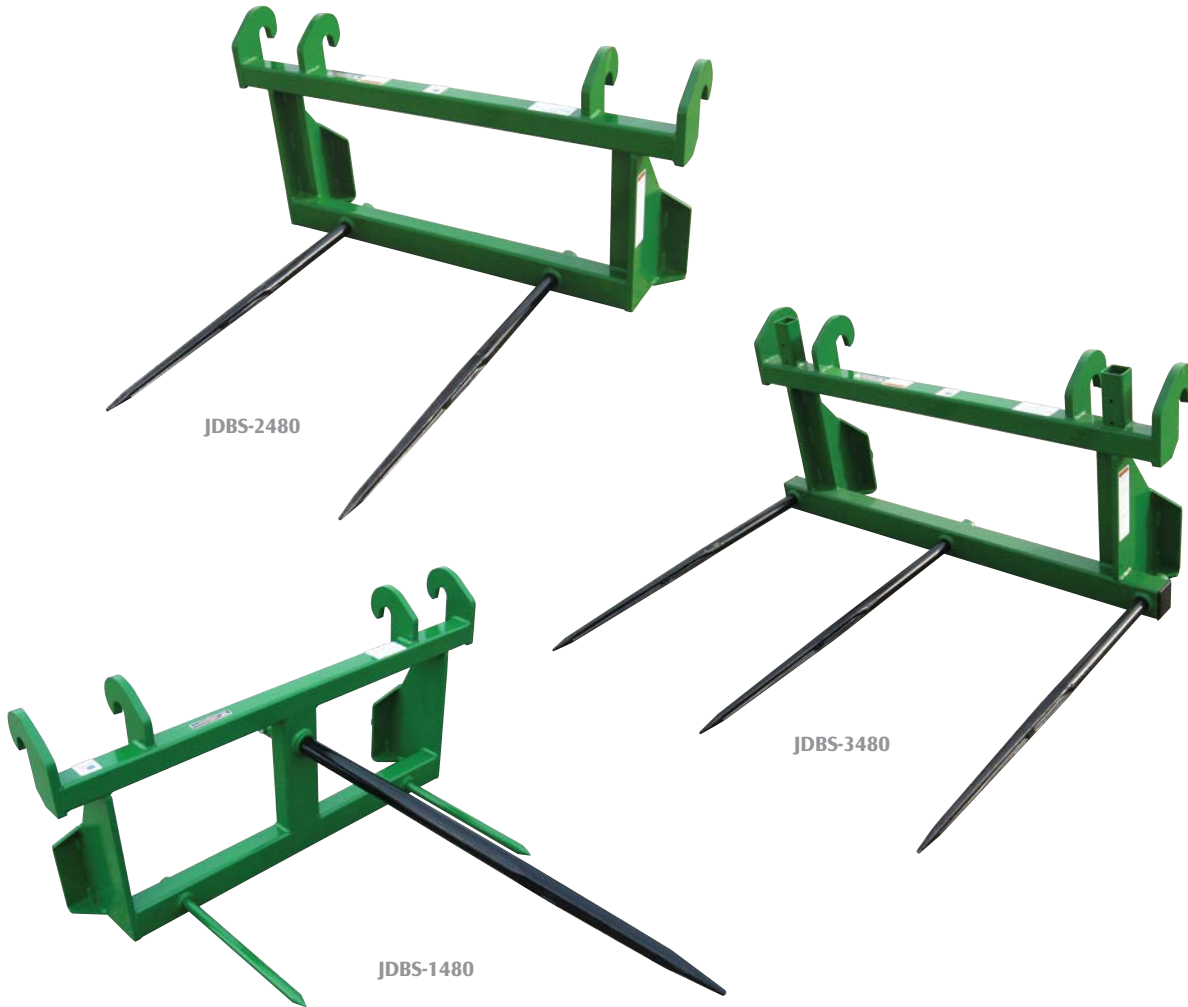

Integrated-Frame Design for John Deere H480 Loader with Global Series II Tool Carrier.

Model	Item No.	Description	Weight
JDBS-1480	834135	Single bolt-in forged spear with usable length of 52". Rated at 2,800 lbs. For handling round bales.	310 lbs.
JDBS-2480	834120	Dual bolt-in forged spears spaced 30" apart, with usable length of 42". Rated at 3,800 lbs. For round bales.	265 lbs.
JDBS-3480	834125	Triple bolt-in forged spears spaced 26" apart, with usable length of 42". Rated at 4,800 lbs. Four larger square bales (use optional upright kit 831095 when handling two bales).	300 lbs.
Optional Bolt-on Upright Kit			
	831095	Optional bolt-on upright kit for handling two bales. Fits model JDBS-3480.	32 lbs.



WARNING: Do not exceed weight lifting capacity of your loader. Damage to equipment or personal injury could occur.



Skid Steer & Front Loader Bale Handling Attachments

Designed for skid steer and tractor front loaders that use the industry standard “universal quick-attach” system. Patented design allows easy access to the skid steer seat with its step through feature. Models are offered for round bales. Forged tapered bolt-in spears allow easy spear penetration of the bale.



SSB-3000



SSRB-340



SSB-2200



SSRB-330
with optional
uprights

Model	Item No.	Description	Weight
SSB-2200	831060	Skid Steer Single Bale Spear. Forged bolt-in spear with usable length of 42". Rated at 2,200 lbs. Two balance spikes.	129 lbs.
SSB-3000	831070	Skid Steer Dual Bale Spear. Forged bolt-in spears with usable length of 42". Rated at 3,000 lbs.	146 lbs.
SSRB-340	831090	Skid Steer Triple Bale Spear. Forged bolt-in spears spaced 26" apart, with usable length of 42". For handling single or double (with optional uprights # 831095) large-size square bales. Rated at 4,000 lbs.	190 lbs.
SSRB-330	831080	Skid Steer Triple Bale Spear. Forged bolt-in spears spaced 26" apart, with usable length of 26". For handling single or double (with optional uprights # 831095) mid-size square bales. Rated at 3,000 lbs.	165 lbs.
Optional Bolt-on Uprights			
	831095	Optional bolt-on uprights for SSRB-330 & SSRB-340 allow handling two bales at once.	32 lbs.



WARNING: Do not exceed weight lifting capacity of your loader. Damage to equipment or personal injury could occur.

Euro/Global Style Integrated Frame Bale Spears

All welded frame design that incorporates the Euro/Global interface. Designed to fit tractor loaders with the widely used Euro/Global tool carrier. Models are offered to handle round bales as well as rectangular bales. All units feature bolt-in forged spears for easy spear penetration of the bale.

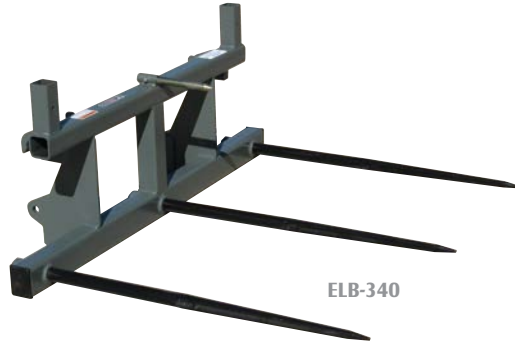

Model	Item No.	Description	Weight
GLB-2200	832205	Single bolt-in forged spear with usable length of 42". Two balance spikes. For round bales. Rated at 2,200 lbs.	130 lbs.
GLB-3000	832220	Dual bolt-in forged spears spaced 30" apart, with usable length of 42". For round bales. Rated at 3,000 lbs.	144 lbs.
ELB-330	832365	Triple bolt-in forged spears spaced 26" apart, with usable length of 26". For handling single or double (with optional uprights #831095) mid-size square bales. Rated at 3,000 lbs.	175 lbs.
ELB-340	832370	Triple bolt-in forged spears spaced 26" apart, with usable length of 42". For handling single or double (with optional uprights #831095) large-size square bales. Rated at 4,000 lbs.	200 lbs.
GDBH-6000	834155	Designed to transport two round bales at once. Frame size 76" x 24" with 4 bolt-in spears with 42" useable length. Rated at 6,000 lbs.	265 lbs.
Optional Bolt-on Upright Kit			
	831095	Optional uprights for ELB-330 & -340.	32 lbs.



WARNING: Do not exceed weight lifting capacity of your loader. Damage to equipment or personal injury could occur.

Choose the **WORKSAVER** Way to Handle Your Hay



RBH-4000G

Rectangular Bale Handler

Designed to handle and stack large rectangular bales, either two 4' x 4' x 8' or three 3' x 3' x 8'. Features include heavy-duty UHMW-polyethylene bushings for smooth operation, hydraulic cylinder, five 26" long and six 18" long forged spears for bale support. Each side features five hooks that are moveable to the most convenient location for handling your bales. Unit measurement is overall width 79.50" and overall height 80".

Model	Item No.	Description	Weight
RBH-4000	831460	Large Rectangular Bale Handler, rated at 4,000 lbs. Designed for tractor front loaders. Optional pin-on brackets or interfacing brackets for most popular quick-attach front loaders are available (loader arm distance of 54" or less).	881 lbs.
RBH-4000G	831487	Large Rectangular Bale Handler for tractor front loaders with Euro/global carrier system. Rated at 4,000 lbs.	870 lbs.



Caution — A heavy load can cause your tractor to tip over. When moving heavy loads, keep the load as close to the ground as possible, go slowly around turns, and be sure the front or rear of tractor is properly counterbalanced with weights.

Caution — Operators must read & understand operator's manual, particularly the safety warnings and instructions. **The operator is responsible for safety of themselves and others when operating equipment.**



WORKSAVER, INC. has a corporate policy of continuous product improvement and development; therefore, specifications are subject to change without any advance notice.

WORKSAVER, INC. is not responsible for differences between specifications or illustrations contained in this publication and the actual equipment.



Distributed by:



Worksaver, Inc.

P.O. Box 100, Litchfield, IL 62056-0100

Phone: 217-324-5973 • Fax: 217-324-3356

www.worksaver.com • E-mail: sales@worksaver.com

Designed. Engineered. Remarkable Value.